

SD-17 WIRING DIAGRAM 2

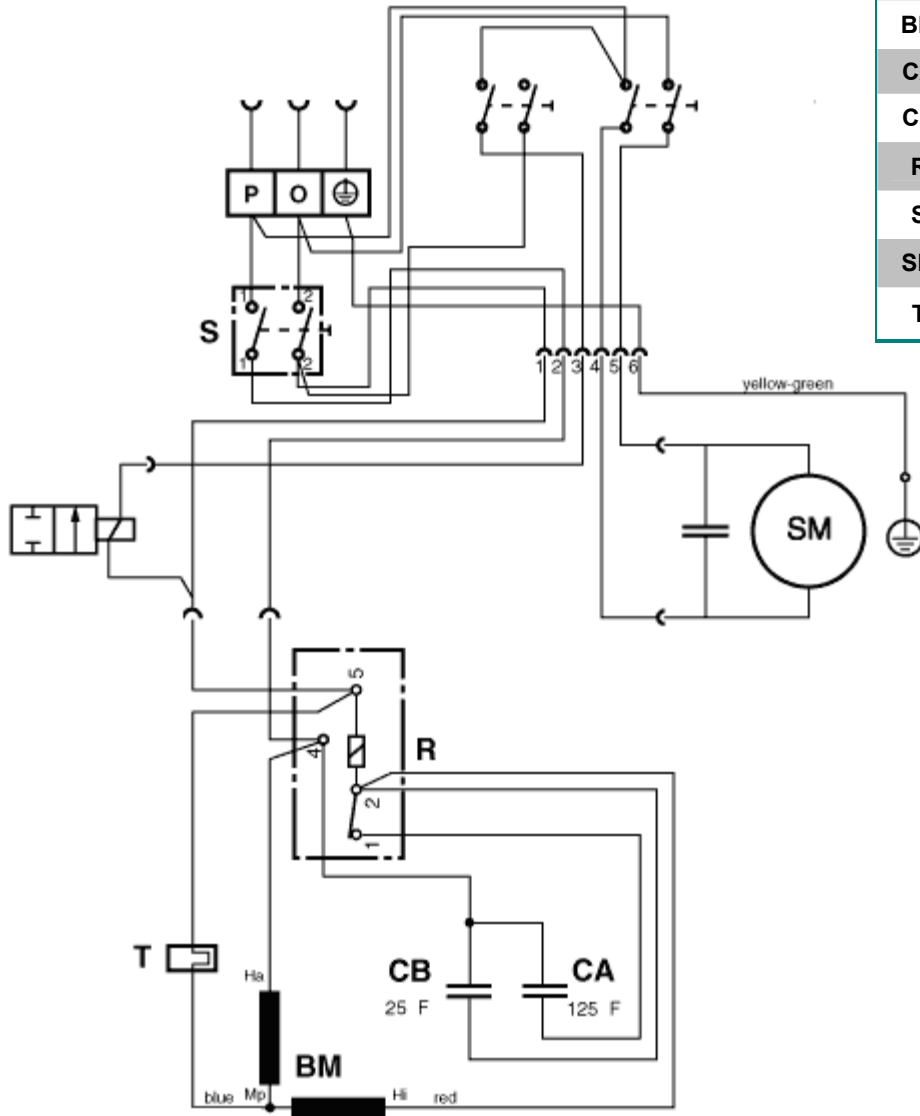

Pos.	Description	Reference
BM	Motor	742.121
CA	Capacitor 125 μ F	742.328
CB	Capacitor 25 μ F	P...385J
R	Relais	6630443
S	Tumbler switch for motor	6650454
SM	Vacuum motor	430.491
T	Thermostat	